

ECO TRAVEL

SPARE PARTS



Pricelist is valid from 1.01.2025 until the new one is published.

INFORMATION



Transportation costs

We deliver free of charge from a net order value of 50 euros. Below a net order value of 50 euros, there are packaging and freight costs of 15 euros. Until full payment has been received all products remain the property of Rehasense Sp. z o.o.



Customer Service **MON-THUR 8:00-16:00; FR 8:00-15:00**

ALEKSANDRA MASIAREK DE/ENG/PL

Customer Service Center Manager

E: aleksandra.masiarek@rehasense.com

M DE: +49 176 588 788 04

M PL: +48 668 027 062

JUSTYNA TOKARSKA DE/PL

E: justyna.tokarska@rehasense.com

M DE: +49 176 588 788 02

M PL: +48 514 749 831

T: +49 2821 590 8587

F: +49 2821 391 4308

MONIKA WIDAWSKA-STĘPIEŃ DE/PL

E: monika.widawska-stepien@rehasense.com

M DE: +49 176 588 788 03

M PL: +48 502 728 409

T: +49 2821 590 8587

F: +49 2821 391 4308

IGA SUSKA-PASIKOWSKA DE/PL

E: iga.suska-pasikowska@rehasense.com

M DE: +49 176 588 788 05

M PL: +48 880 385 887

EWELINA CIEŚLAK ENG/PL

E: ewelina.cieslak@rehasense.com

M PL: +48 788 993 070

MARTA DERDA ENG/PL

E: marta.derda@rehasense.com

M PL: +48 662 916 452

MICHAŁ KAROLIŃSKI ENG/PL

E: michal.karolinski@rehasense.com

M PL: +48 662 916 465

PIOTR MACIEJAK ENG/PL

E: piotr.maciejak@rehasense.com

M PL: +48 884 277 975



Please send orders by email to the following address: info@rehasense.com

This is the quickest and easiest way. Thanks very much! Your Rehasense customer service

ORDER FORM



Please help us save paper. Please send your orders by e-mail to info@rehasense.com. Thank you very much!

Company name :	Date:
Customer ID nb:	Order nb:
Contact person:	Delivery address
E-Mail:	Street & House nb:
Tel./Fax:	Zip code & Town:

TECHNICAL DRAWING FOR ECO TRAVEL

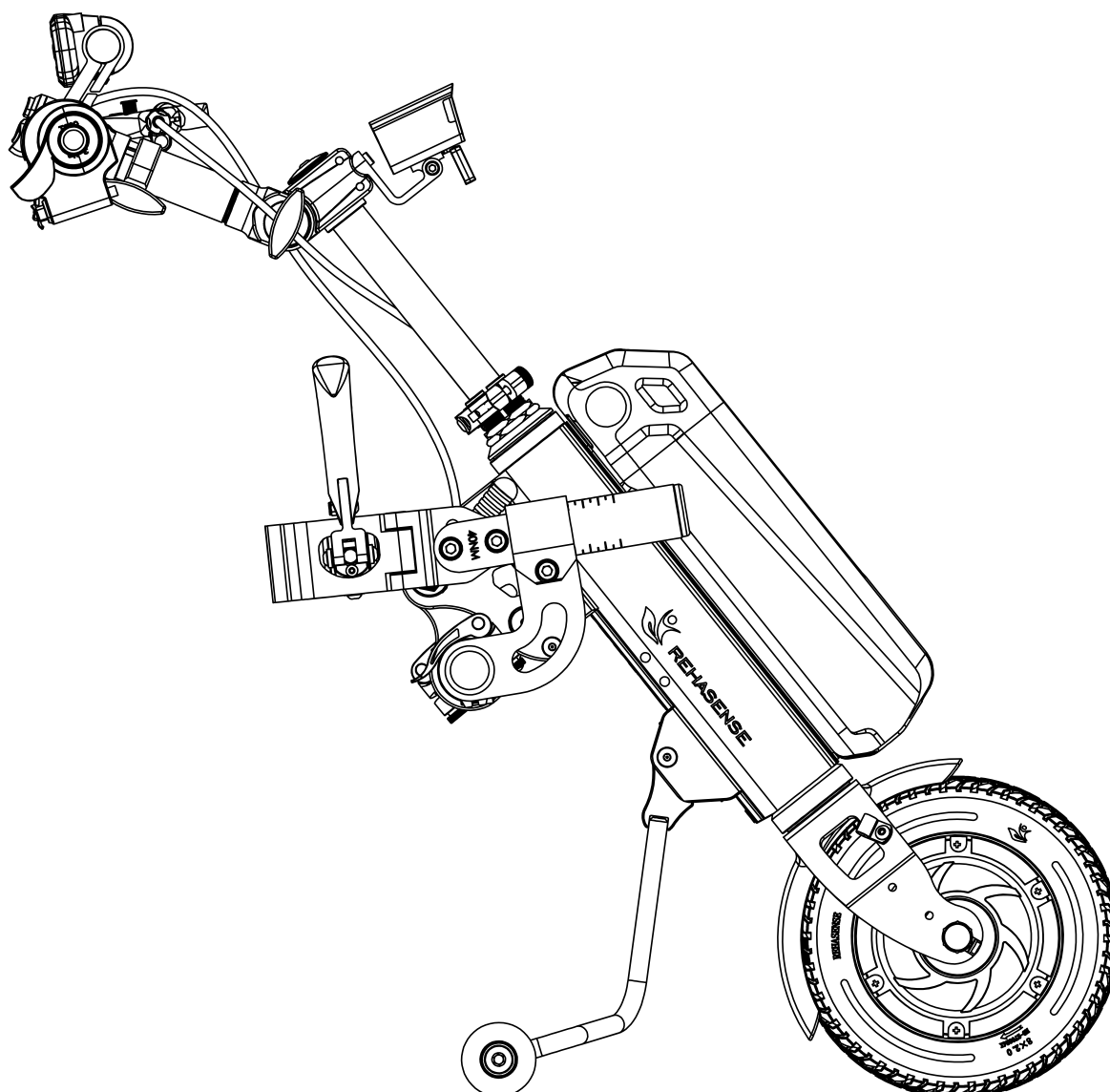

No.	Picture	Item description	Item no	Order qty	Net Price
1		Display with ET Lx programming	EBE000E-T		
2		Battery holder/controller with ET Lx programming	EBE005E-A		
3		ET Lx 8" wheel motor with rubber tire, 350W	EBT08A-P		
4		ET Lx Throttle with cruise control, driving direction and e-brake buttons	EBH00Z-3		
5		Foldable handlebar for ET Lx	EBH00X-P		
6		ET Lx display holder	EBH205A-P		
7		Stem bar for ET Lx 180-215MM with finger screws and holes for lamp	EBH06GA		
8		Support legs with wheels, black	EBL00X-BKP		
		Support legs with wheels, orange	EBL00X-ORP		
		Support legs with wheels, red	EBL00X-REP		
		Support legs with wheels, green	EBL00X-GRP		
		Support legs with wheels, blue	EBL00X-BLP		
9		Rubber wheel for Lx support leg	EBL021		
10		Soft shell suitcase for ET Lx, includes foam padding	IVR003		
11		Integrated waterproof cable harness for ET Lx	EBE00B3-P		







No.	Picture	Item description	Item no	Order qty	Net Price
12		Display with ET Bx programming	EBE00SW-P		
13		Battery holder/controller with ET Bx programming	EBE005E-S		
14		ET Lx 8" wheel motor with rubber tire, 250W	EBT08B-P		
15		ET Bx throttle with driving direction switch and e-brake button	EBE00H1-SP		
16		Handlebar tube for ET Bx, L=480 mm	EBH002		
17		Stem bar 110 mm for ET Bx, with finger screws and holes for lamp	EBH07GA		
18		Support legs without wheels for ET Bx	EBL00Y-BKP		
19		Integrated waterproof cable harness for ET Bx	EBE00B2-P		

No.	Picture	Item description	Item no	Order qty	Net Price
20		Charger 2A for ECO Travel battery	EBBC046		
21		ECO Travel battery with black stickers, 48V 5.8Ah, 278Wh	EBB0048T-B		
		Spare ECO Travel black stickers	5410WV-A		
22		ECO Travel battery with orange stickers, 48V 5.8Ah, 278Wh	EBB0048T-O		
		Spare ECO Travel orange stickers	5410WV-B		
23		ECO Travel battery with red stickers, 48V 5.8Ah, 278Wh	EBB0048T-R		
		Spare ECO Travel red stickers	5410WV-C		
24		ECO Travel battery with green stickers, 48V 5.8Ah, 278Wh	EBB0048T-G		
		Spare ECO Travel green stickers	5410WV-D		
25		ECO Travel battery with blue stickers, 48V 5.8Ah, 278Wh	EBB0048T-L		
		Spare ECO Travel blue stickers	5410WV-E		
26		ECO Travel mudguard, Black	EBF056-BKP		
		ECO Travel mudguard, Orange	EBF056-ORP		
		ECO Travel mudguard, Red	EBF056-REP		
		ECO Travel mudguard, Green	EBF056-GRP		
		ECO Travel mudguard, Blue	EBF056-BLP		
27		QR-clamp assembly for height fixation, 32 mm	EBA232-P		
28		Center column locking nut, M32X1.25	EBF065A-P		

No.	Picture	Item description	Item no	Order qty	Net Price
29		Default Manual clamp 50 mm for round tubes Right	EBX035-BK		
30		Default Manual clamp 50 mm for round tubes, Left	EBX036-BK		
31		Clamp arm tube, 160 / 100 mm	EBC213-BK		
		Long clamp tube, 210 / 150 mm	EBC213A-BK		
32		Default bracket 100 mm with 80 mm raised clamp holder, Right	EBC220A		
33		Default bracket 100 mm with 80 mm raised clamp holder, Left	EBC220B		
34		Limit ring	EBC206-SL		
35		Head lamp / horn, cable L=120 mm	EBE008		
36		Lamp bracket	EBH209-BKP		
37		Central lifting unit housing	EBA224-P		
38		ET center piece	EBA225-P		
39		Complete width adjustment locking clamp, fits both sides	EBA221		
40		Left side brake lever with parking brake	EBE01S-P		
		Right side brake lever with parking brake	EBE01W-P		

No.	Picture	Item description	Item no	Order qty	Net Price
41		Lamp/horn button with 2 light modes – 1500 and 400 lumens	EBE028A		
		Lamp/horn button with 1 low light mode – 400 lumens	EBE028A1-P		
42		QR lever for manual lifting unit	EBA234-P		
43		Complete drum brake cable, 1059 mm	69105R-P		
44		Tyre 8" x 2", 200 x 50, with honeycomb inside	430800		
45		Anti rotation washer for ECO Travel	EBF008		
		Wheel locking nut for ECO Travel	EBF009		
		Nord-lock washer	1925DF-P		
46		ECO Travel brake plate replacement	EBF001		
47		Lift release cable, 720 mm	EBA205C-P		
48		Handlebar grip	EBE00L-S		
49		Telescopic tube weldment	EBH197-BKP		
50		Plastic bushing for telescopic steering bar	EBF066-P		
51		Longer spindle for larger opening required for tube diameter over Ø32 mm	EBX058L		
52		Spring for support legs	64106F		
53		Big suitcase wheel	150520-P		
54		Finger screw long	EBH108-L		
		Finger screw short	EBH108		
55		Brass bushing for finger screws	64507Q		
56		Safety lock for clamp handle which prevents unwanted clamp opening during driving	EBX035-S		

No.	Picture	Item description	Item no	Order qty	Net Price
57		Standard clamp 50 mm with safety lock – Left	EBX035T-BK		
		Standard clamp 50 mm with safety lock- Right	EBX036T-BK		
58		70 mm clamp for round tubes – Left	EBX03C-BK		
		70 mm clamp for round tubes – Right	EBX03D-BK		
59		Clamps 50 mm for Kuschall K2, K1, Meyra FUSE R and OFFCARR Themis tube profiles, Left	EBX06F-BK		
		Clamps 50 mm for Kuschall K2, K1, Meyra FUSE R and OFFCARR Themis tube profiles, Right	EBX06E-BK		
60		Clamps 70 mm for Kuschall K2, K1, Meyra FUSE R and OFFCARR Themis tube profiles, Left	EBX06H-BK		
		Clamps 70 mm for Kuschall K2, K1, Meyra FUSE R and OFFCARR Themis tube profiles, Right	EBX06G-BK		
61		Clamp 50 mm for Oval tubes - Left	EBX07A-BK		
		Clamp 50 mm for Oval tubes – Right	EBX07B-BK		
62		Clamp 70 mm for Oval tubes – Left	EBX07C-BK		
		Clamp 70 mm for Oval tubes – Right	EBX07D-BK		
63		40 mm clamp for round tubes – Left	EBX03A-BK		
		40 mm clamp for round tubes – Right	EBX03B-BK		
64		Clamp 50 mm with cut-out for T-joint – Left	EBX03F-BK		
		Clamp 50 mm with cut-out for T-joint – Right	EBX03E-BK		

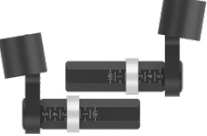
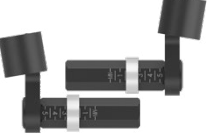
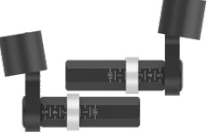
No.	Picture	Item description	Item no	Order qty	Net Price
65		Elevated Clamp Arm, Right Side, Arm = 150, L60 x H80 mm	EBC220A2		
		Elevated Clamp Arm, Right Side, Arm L = 190, L60 x H80 mm	EBC220A3		
66		Elevated Clamp Arm, Left Side, Arm L = 150, L60 x H80 mm	EBC220B2		
		Elevated Clamp Arm, Left Side, Arm L = 190, L60 x H80 mm	EBC220B3		
67		Elevated Clamp Arm Right Side, Arm L = 100, L60 x H130 mm	EBC220C		
		Elevated Clamp Arm Right Side, Arm L = 150, L60 x H130 mm	EBC220C2		
		Elevated Clamp Arm, Right Side, Arm L = 190, L60 x H130 mm	EBC220C3		
68		Elevated Clamp Arm, Left Side, Arm L = 100, L60 x H130 mm	EBC220D		
		Elevated Clamp Arm, Left Side, Arm L = 150, L60 x H130 mm	EBC220D2		
		Elevated Clamp Arm, Left Side, Arm L = 190, L60 x H130 mm	EBC220D3		
69		Elevated Clamp Arm, Right Side, Arm L = 100, L60 x H190 mm	EBC220E		
		Elevated Clamp Arm, Right Side, Arm L = 150, L60 x H190 mm	EBC220E2		
		Elevated Clamp Arm, Right Side, Arm L = 190, L60 x H190 mm	EBC220E3		
70		Elevated Clamp Arm, Left Side, Arm L = 100, L60 X H190 mm	EBC220F		
		Elevated Clamp Arm, Left Side, Arm L = 150, L60 x H190 mm	EBC220F2		
		Elevated Clamp Arm, Left Side, Arm L = 190, L60 x H190 mm	EBC220F3		
71		Elevated Clamp Arm, Right Side, Arm L = 100, L60 x H80 mm, Angled	EBC220G		
		Elevated Clamp Arm, Left Side, Arm L = 100, L60 x H80 mm, Angled	EBC220H		
72		Elevated Clamp, Right Side. Arm L = 100, L60 x H130 mm, Angled	EBC220J		
		Elevated Clamp, Left Side. Arm L = 100, L60 x H130 mm, Angled	EBC220K		
73		Elevated Clamp, Right Side, Arm L = 100, L60 x H190 Mm, Angled	EBC220L		
		Elevated Clamp, Left Side, Arm L = 100, L60 x H190 mm, Angled	EBC220R		



Your Notes

A series of horizontal dotted lines for writing notes, starting below the 'Your Notes' header and extending to the bottom of the page.



REHASENSE

REHASENSE UK
UNIT 5, GUILFORD ROAD
INDUSTRIAL ESTATE
HAYLE, CORNWALL, TR27 4BA
UNITED KINGDOM
☎ +44 (0) 333 220 0704
✉ UKADMIN@REHASENSE.COM

REHASENSE SP. Z O.O.
SULEJOWSKA 45G
97-300 PIOTRKÓW TRYBUNALSKI
POLAND
☎ +48 880 331 272
✉ INFO@REHASENSE.COM

REHASENSE DEUTSCHLAND GMBH
STERNBERGER STRASSE 12,
32699 EXTERTAL,
GERMANY
☎ +49 5262 5709326
✉ INFO@REHASENSE.COM

REHASENSE DENMARK
GLARMESTERVEJ 16 A, ST. TV.
8600 SILKEBORG,
DENMARK
☎ +49 176 588 788 01
✉ INFO@REHASENSE.COM

REHASENSE BENELUX
MARKEWEG 81
8398GM BLESIJKE,
NETHERLANDS
☎ +31 653 837 211
✉ INFO@REHASENSE.NL

REHASENSE FRANCE
50 IMPASSE DES MOULINS
38300 RUY-MONTCEAU
FRANCE
☎ +33 (0) 4 74 93 12 38
✉ INFO-FR@REHASENSE.COM

REHASENSE KOREA
1F. 338-46, DONGBUSUNHWAN-RO,
WONJU-SI 26454 GANGWON-DO,
REPUBLIC OF KOREA
☎ +82 070 4216 3429
✉ JONGSUNG.KIM@REHASENSE.COM

REHASENSE MOBILITY CANADA LTD
56 CHURCHILL DRIVE, UNIT # 5&6
BARRIE, ONTARIO, L4N8Z5
CANADA
☎ +1 249 388 3197
✉ INFOCANADA@REHASENSE.COM

REHASENSE USA
1208 N. INDEPENDENCE BLVD
ROMEDEVILLE IL. 60446
USA
☎ +1 630 756 3099
✉ INFO-USA@REHASENSE.COM

REHASENSE CHINA
NO.289, WENGJIAO ROAD
XINYANG INDUSTRIAL AREA
361022 HAICANG, XIAMEN,
CHINA
☎ +86 592 688 4014
✉ EVELYN.CHEN@REHASENSE.COM

REHASENSE ITALY SRL
VIALE DELLE INDUSTRIE 5
20044 ARESE (MI) ITALY
☎ +39.02.99 77 08
✉ INFOITALY@REHASENSE.COM

REHASENSE MENA
QETAF MEDICAL EST
3599 PRINCE MOHAMMED BIN
ABDULAZIZ ST,
SAUD LANGAWI CENTER, AL ANDALUS
JEDDAH 23326,
SAUDI ARABIA
☎ +96 650 664 1993
✉ SALES-MIDDLE-EAST@REHASENSE.COM

REHASENSE COLOMBIA
CALLE 171 # 21 A 47
BARRIO LA URIBE, BOGOTÁ
COLOMBIA
☎ +57 3153118652
✉ VANUMANANA@REHASENSECOLOMBIA.COM

REHASENSE NEW ZEALAND
UNIT 4, 260 APIRANA AVENUE
GLEN INNES, AUCKLAND, 1072,
NEW ZEALAND
☎ +09 555 3111
✉ NZ-INFO@REHASENSE.COM

REHASENSE AUSTRALIA PTY LTD
☎ +61 475 856 207
✉ WERNER.PETZER@REHASENSE.COM

